

ZAAP
GREEK



User's Guide

How to use this ZAAPTTM GREEK set-top box

IMPORTANT SAFETY INSTRUCTIONS

- Read and follow these instructions.
- Heed all warnings.
- Do not use this apparatus near water.
- Clean only with dry cloth.
- Do not block any ventilation openings. Install in accordance with the manufacturer's instructions.
- Protect the power cord from being walked on or pinched particularly at plugs, convenience receptacles, and the point where they exit from the apparatus.
- Unplug this apparatus during lightning storms or when unused for long periods of time.
- Refer all servicing to qualified service personnel. Servicing is required when the apparatus has been damaged in any way, such as the power-supply cord or plug is damaged, liquid has been spilled or objects have fallen into the apparatus, the apparatus has been exposed to rain or moisture, does not operate normally, or has been dropped.

IMPORTANT SAFETY CONSIDERATIONS

The ZAAPTV GREEK set-top box requires careful handling to avoid potential damage to its internal parts. Be sure to follow these requirements during transportation and installation. The plug is the main disconnect device. It shall remain readily accessible and operable. The apparatus shall not be exposed to dripping or splashing and no objects filled with liquids, such as vases, shall be placed on the apparatus.

During Transportation to the Subscriber Home

Transport the ZAAPTV GREEK in its shipping box or an equally padded container. Do not expose it to rain or moisture.

During Installation

- Do not place ZAAPTV GREEK in an enclosed area where the cooling vents are blocked or impede the flow of air through the ventilation openings.

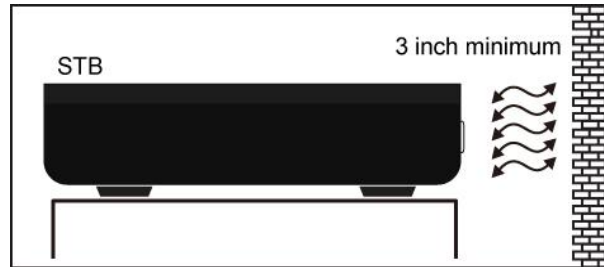

CAUTION!



Do not place anything on top of your ZAAPTV GREEK set-top box, especially other home entertainment components. Be sure to provide adequate ventilation to prevent overheating.

- Install ZAAPTV GREEK on a hard flat surface not prone to vibration or impact and not on top of another electronic device
- Do not install near any heat sources such as radiators, heat registers, stoves, or other apparatus (including amplifiers) that produce heat.

- Installation of ZAAPTV GREEK near consumer electronics devices, such as stereo receiver/amplifiers and televisions, is permitted as long as the air surrounding ZAAPTV GREEK does not exceed 40° C (104° F).
- Do not install ZAAPTV GREEK in an area where condensation occurs.
- To prevent the temporary loss of guide data and cause a temporarily non-responding ZAAPTV GREEK, do not plug the AC power cord into a switched power outlet.

FCC COMPLIANCE

Note: This equipment has been tested and found to comply with the limits for a Class B digital device, pursuant to part 15 of the FCC Rules. These limits are designed to provide reasonable protection against harmful interference in a residential installation. This equipment uses and can radiate radio frequency energy and, if not installed and used in accordance with the instructions, may cause harmful interference to radio communications. However, there is no guarantee that interference will not occur in a particular installation. If this equipment does cause harmful interference to radio or television reception, which can be determined by turning the equipment off and on, the user is encouraged to try to correct the interference by one or more of the following measures:

- Reorient or relocate the receiving antenna.
- Increase the separation between the equipment and set-top box.
- Connect the equipment into an outlet on a circuit different from that to which the set-top box is connected.
- Consult the dealer or an experienced radio/TV technician for help.

Caution: Changes or modifications not expressly approved by ZAAPTV for compliance could void the user's authority to operate the equipment.

This device complies with part 15 of the FCC Rules. Operation is subject to the following two conditions: (1) This device may not cause harmful interference, and (2) this device must accept any interference received, including interference that may cause undesired operation.

FCC Radiation Exposure Statement

The antennas used for this transmitter must be installed to provide a separation distance of at least 20 cm from all persons and must be co-located for operating in conjunction with any other antenna or transmitter.

CARING FOR THE ENVIRONMENT BY RECYCLING

When you see this symbol on a ZAAPTV GREEK product, do not dispose of the product with residential or commercial waste.



Recycling your ZAAPTV GREEK Equipment

Please do not dispose of this product with your residential or commercial waste. Some countries or regions, such as the European Union, have set up systems to collect and recycle electrical and electronic waste items. Contact your local authorities for information about practices established for your region.

© 2014 – 2015 Cloud Antenne Services SÁrl. All rights reserved. No part of this publication may be reproduced in any form or by any means or used to make any derivative work (such as translation, transformation, or adaptation) without written permission from Cloud Antenne Services SÁrl.

Cloud Antenne Services SÁrl and its logo are registered trademark. HDMI, the HDMI Logo and High-Definition Multimedia Interface are trademarks or registered trademarks of JDMI Licensing LLC. All other product or service names are the property of their respective owners. All rights reserved.

Cloud Antenne Services SÁrl reserves the right to revise this publication and to make changes in content from time to time without obligation on the part of Cloud Antenne Services SÁrl to provide notification of such revision or change. Cloud Antenne Services SÁrl provides this guide without warranty of any kind, implied or expressed, including, but not limited to, the implied warranties of merchantability and fitness for a particular purpose. Cloud Antenne Services SÁrl may make improvements or changes in the product(s) described in this manual at any time.

CONTENTS

1.	INTRODUCTION	9
	Front Panel	11
	Rear Panel.....	12
2.	OPERATION.....	13
	Turning Power On and Off	13
	Changing Channels	13
	Adjusting the Volume.....	13
	Interactive Programming Guide	14
	Video Output Format Option.....	14
3.	CONNECTING YOUR ZAAPTV GREEK SET TOP BOX TO YOUR HOME	15
4.	HOW TO MANUALLY CONFIGURE THE ZAAPTV GREEK SET-TOP BOX	20
5.	TROUBLESHOOTING	30

1. INTRODUCTION

We congratulate you on receiving this ZAAPTV GREEK Series High-Definition All-Digital set-top box, one of the most compact and advanced interactive digital IPTV set-top boxes available today. ZAAPTV GREEK has combined the extraordinary features of IPTV — the interactive programming guides, almost endless programming options, Video on Demand (VOD), the incredible sound and picture quality of High-Definition TV (HDTV), and so much more. This set-top box comes with an “Entertainment Package” that enables a direct digital connection to consumer audio and video devices through HDMI™ interfaces. The HDMI interface and provides 7.1 channels and beyond enhanced-quality audio and video. It comes with a CVBS-connector just in case your TV set doesn't support High-Definition TV. It's also equipped with a built-in WiFi module, so that you can seamlessly connect it to your home network and/or Internet without the need of a network cable (although it is included in the package). This User's Guide introduces you to the basic features, outlines important safeguards, and provides several options for integrating this component into your current home entertainment system. Please take a few minutes to read through this User's Guide to help you maximize the most of your home entertainment experience: the configuration diagrams, on-screen menu description and a troubleshooting section. To determine which features of digital IPTV service are provided in your service area, please check with your IPTV operator. They will be happy to provide instructions for some of these optional services.

Features

- Video format support: MPEG-1 MPEG-2 MP@HL, MPEG-4.2 ASP, MPEG 4.10 AVC (H.264 & H.263), MP & HPTO LEVEL 4.1, VC-1 AP@L3, WMV9, SD & HD, DIVX, AVI, AVS, XVID.
- Audio format support: MPEG-1 LAYER 1,2. MP3, WMA, WMA PRO, AAC LC, AA LC+SBR L2, AAC+L2, AAC+L4, AAC 5.1.
- Support many display modes: PAL, NTSC, 720p, 1080i, Full HD 1080p.*
- Support aspect ratios: 4:3 and 16:9 letterbox, zoom, and full screen mode.
- HDMI 1.4, T-connector (for Component & Composite), Digital Audio (S/PDIF), Audio L/R, Ethernet, USB.
- 1080p 24/30 video decode & output support
- Support 802.11n 150 Mb/s WiFi

**Some televisions may not support all video formats listed above.*

Front Panel

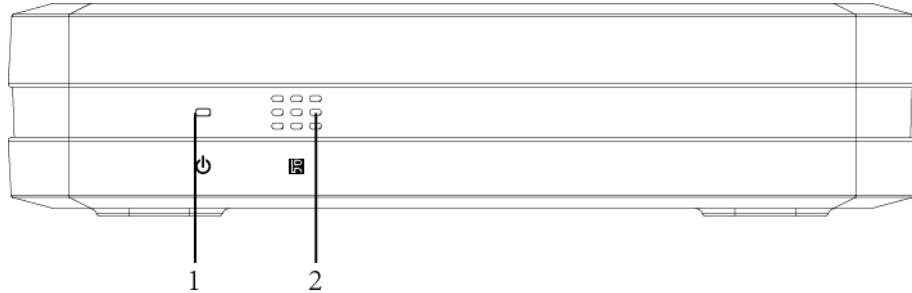

** Availability of certain features is dependent upon application support.*

1	Power and Activity LED
2	IR Receiver

Rear Panel

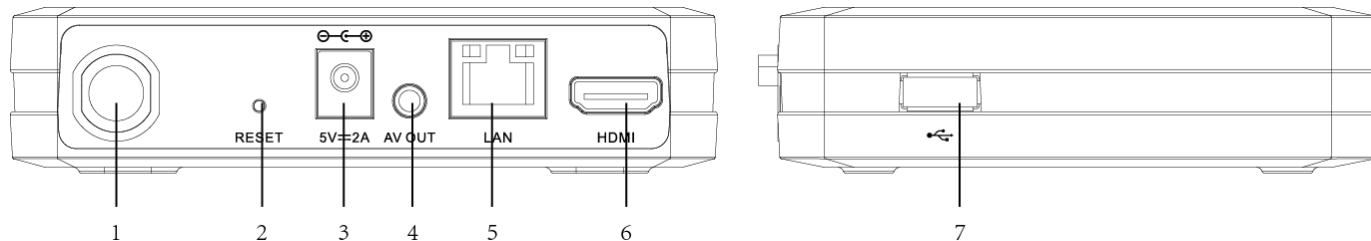

** Availability of certain features is dependent upon application support.*

1	WIFI Antenna
2	Reset Button
3	Power
4	AV Output
5	LAN/Ethernet/RJ-45
6	HDMI 1.4
7	USB 2.0

2. OPERATION

Turning Power On and Off

Plug in the supplied power adapter to the electrical outlet and to the back of ZAAPTV GREEK set-top box or use a remote control to turn it on or off (standby). When using the remote control, pressing the POWER button once will put ZAAPTV GREEK set-top box on a standby mode while pressing and holding the same button for approximately 3 seconds will turn it off.

Changing Channels

You can change channels in three ways:

- Press CHANNEL + or – on the remote control to step through the channel selection.
- Enter the number of the channel you wish to view using the number keys on the remote control.
- Select the channel in the Interactive Program Guide.

Adjusting the Volume

Press VOLUME + or – on the remote control to adjust the volume. When you adjust the volume, the volume scale is displayed on the screen. Press MUTE on the remote control to toggle the sound on and off. For best audio quality when using the analog L/R (var.) volume controlled audio outputs, use the remote control to set the ZAAPTV GREEK set-top to approximately three quarters of the maximum volume level and then adjust the audio levels on external devices such as your TV or A/V receiver. When using the analog L/R (fixed) audio outputs or any of the digital audio outputs (HDMI, optical or coaxial digital audio) adjust the audio levels on your external device such as your TV or A/V receiver. You may

also be able to program your remote to control the volume of your TV or A/V receiver directly (refer to the remote control instruction manual).

Interactive Programming Guide

The Interactive Programming Guide displays information about TV programs and enables you to access features such as Parental Control or Pay-Per-View. Interactive program guides may vary with each service provider.

Video Output Format Option

ZAAPTV GREEK set-top box allows you to quickly change the video output format used by the Composite Video, and HDMI outputs. The ZAAPTV GREEK set-top box is capable of providing the following video formats on the HDMI video outputs:

- High Definition 1080i (1920 x 1080 pixels)
- High Definition 720p (1280 x 720 pixels)
- Enhanced Definition 480p (720 x 480 pixels)
- Standard Definition 480i (720 x 480 pixels)
- The ZAAPTV GREEK set-top box is also capable of passing through High-Definition 1080p 24/30 (1920 x 1080 pixels) source content over the HDMI video output.

ZAAPTV GREEK allows you to select a video output format that is compatible with a connected display device. This option provides an easy method for selecting an output format that is compatible with your television.

3. CONNECTING YOUR ZAAPTV GREEK SET TOP BOX TO YOUR HOME

Instructions and diagrams are included for the following connections:

- High-Definition Television (HDTV)
- Standard-Definition TV (SDTV)
- WiFi Router
- Before you move or change components on your entertainment system, review the following:
- Disconnect power from your equipment before connecting or changing connections. For information on connecting to an HDTV, see the Video Connection Options page.

HDMI provide video and audio, so no separate audio connections are required if you plan to use your TV's speakers as the primary audio source.

Composite video — SDTV

If a HDMI input is not available on your TV, use the composite video (video) connection. Note: Composite video does not provide audio. A separate audio connection must be made.

HDMI

If your TV has an HDMI input, this is for both audio and video if you are using the TV speakers. Connect the provided HDMI cable to the TV and to the HDMI connector on your ZAAPTTM GREEK set-top box.

Connecting ZAAPTTM GREEK with HDMI connector

Please see the setup diagram below :

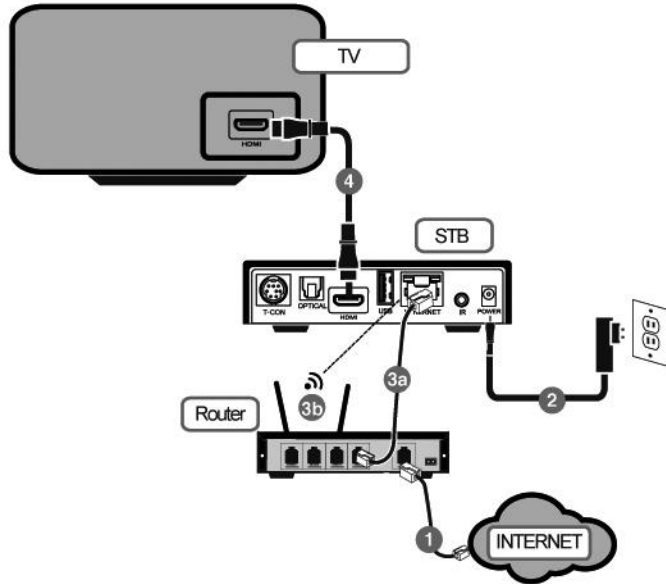

Please follow the instructions below:

1. Make sure you're connected to the Internet without any problem (either with a router or a modem).
2. Plug in the power adapter of the ZAAPTV GREEK set-top box to the nearby power outlet.
- 3a. Connect the network cable from the set-top box to the router.
- 3b. Alternatively you can also connect the set-top box wirelessly to your wireless router. This option is only available if your ZAAPTV GREEK set-top box has a wireless module in it and you have a working wireless router. You can setup the wireless connection later in the Settings page.
4. Connect the HDMI cable with the small connector head to the set-top box while the big connector head to your TV.

Connecting ZAAPTV GREEK with Composite video connector

Please see the setup diagram below :

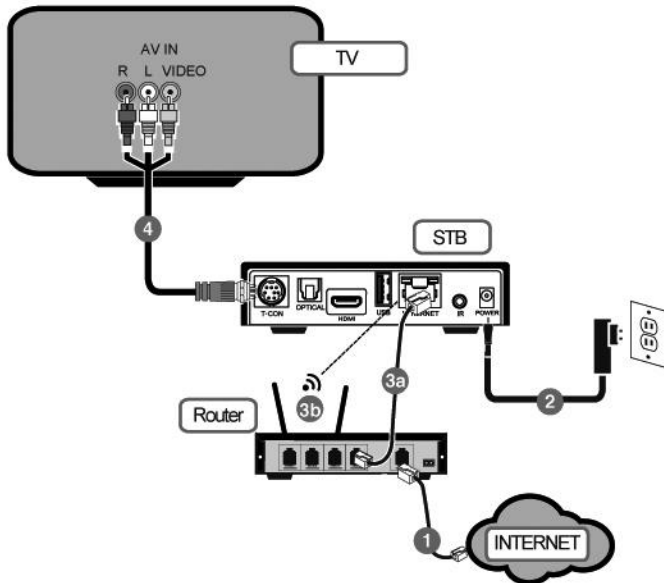

Please follow the instructions below:

1. Make sure you're connected to the Internet without any problem (either with a router or a modem).
2. Plug in the power adapter of the ZAAPTV GREEK set-top box to the nearby power outlet.
- 3a. Connect the network cable from the set-top box to the router.
- 3b. Alternatively you can also connect the set-top box wirelessly to your wireless router. This option is only available if your ZAAPTV GREEK set-top box has a wireless module in it and you have a working wireless router. You can setup the wireless connection later in the Settings page.
4. Connect the HDMI cable with the small connector head to the set-top box while the big connector head to your TV.

Connecting ZAAPTV GREEK with Component

video connector

Please see the setup diagram below :

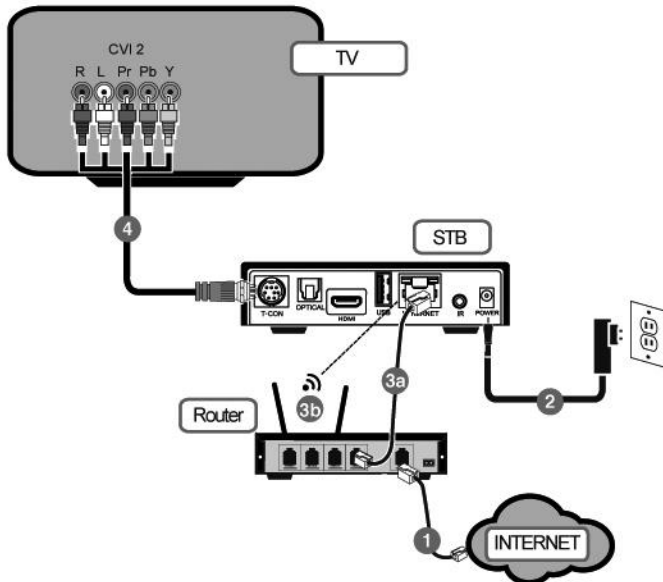

Please follow the instructions below:

1. Make sure you're connected to the Internet without any problem (either with a router or a modem).
2. Plug in the power adapter of the ZAAPTV GREEK set-top box to the nearby power outlet.
- 3a. Connect the network cable from the set-top box to the router.
- 3b. Alternatively you can also connect the set-top box wirelessly to your wireless router. This option is only available if your ZAAPTV GREEK set-top box has a wireless module in it and you have a working wireless router. You can setup the wireless connection later in the Settings page.
4. Connect the HDMI cable with the small connector head to the set-top box while the big connector head to your TV.

4. HOW TO MANUALLY CONFIGURE THE ZAAPTVM GREEK SET-TOP BOX

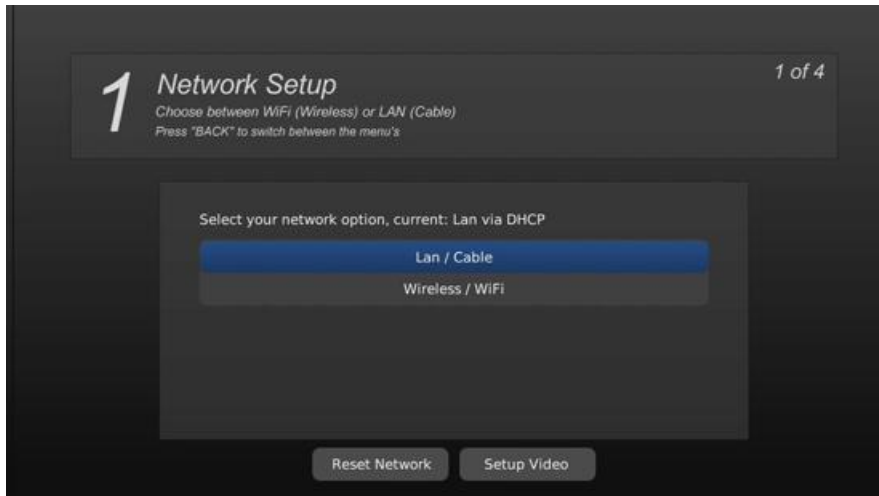

Use the **remote** control buttons to navigate up and down and **OK** to confirm a selection.

Step 1) Select your network.

Select **Lan/Cable** if your set-top box is connected via a cable or **Wireless/WIFI** if you connect wireless to Internet.

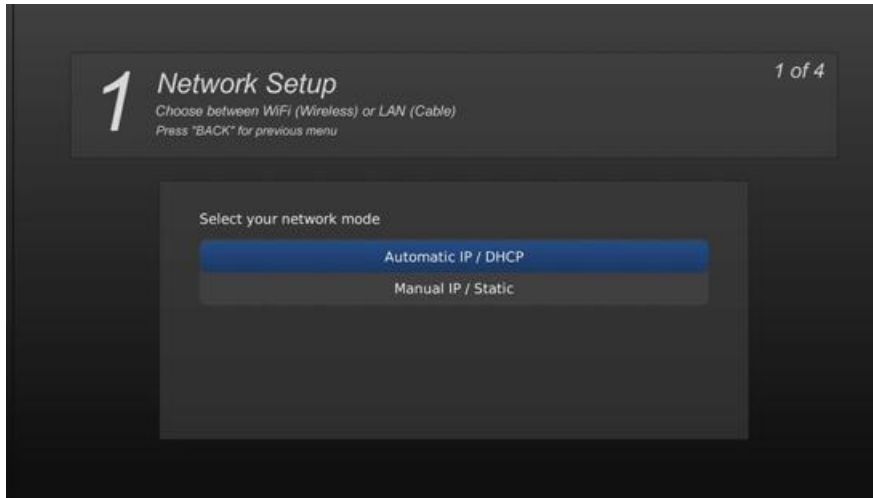

Step 2) Select network connection modus.

DHCP will assign automatic an IP to the set-top box. In **STATIC** mode you can configure your set-top box manual.

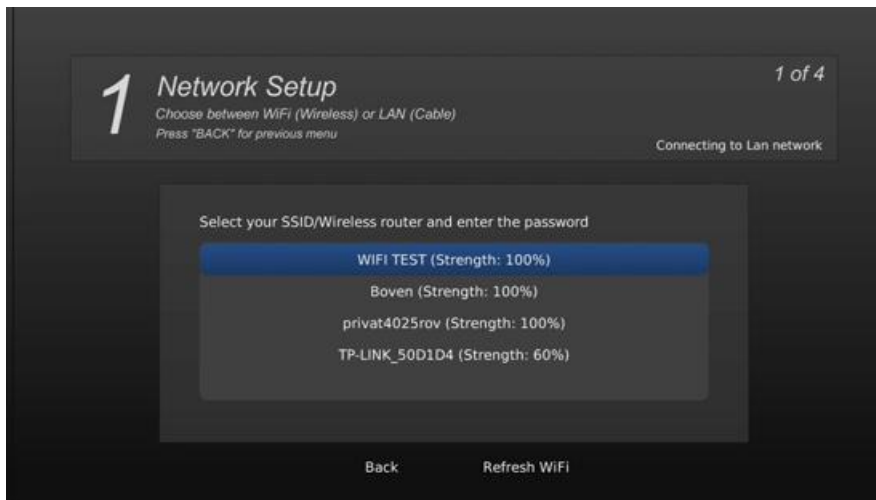

Step 3) When **Wireless** selected chose the SSID router.

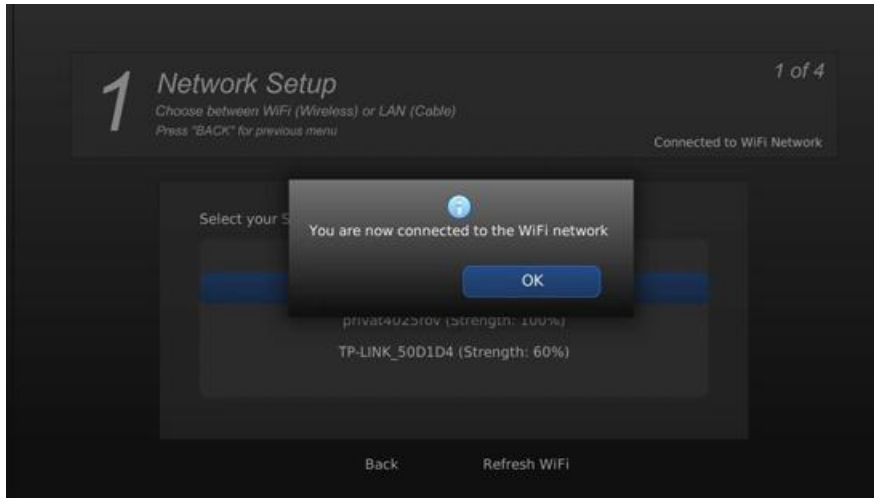

Step 4) **Confirm** network settings.

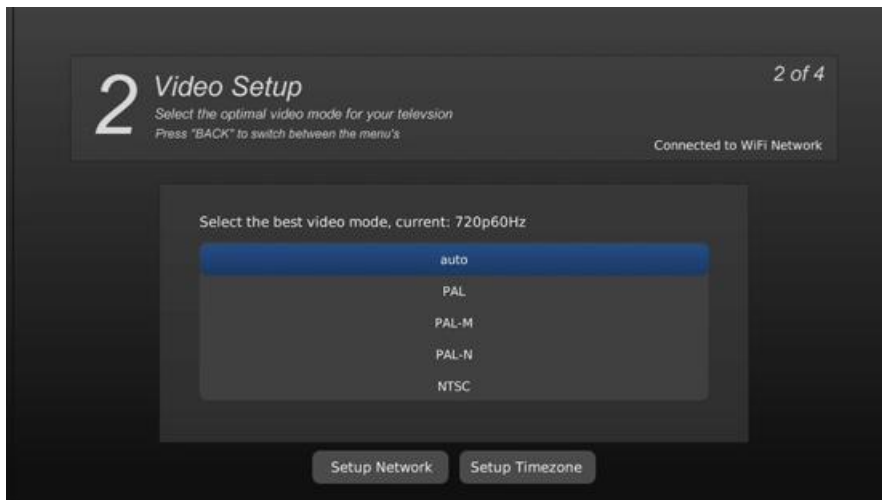

Step 5) Select **video** modus.

Please base your selection on what your television can support.

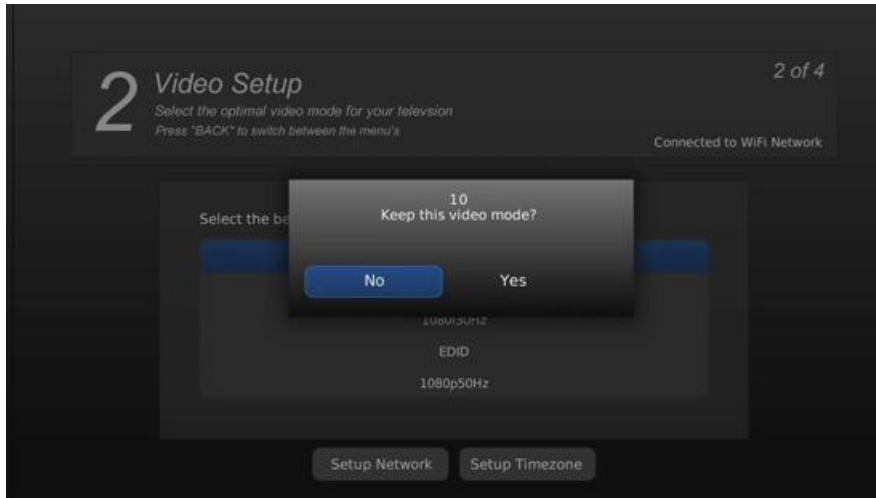

Step 6) **Confirm** video selection.

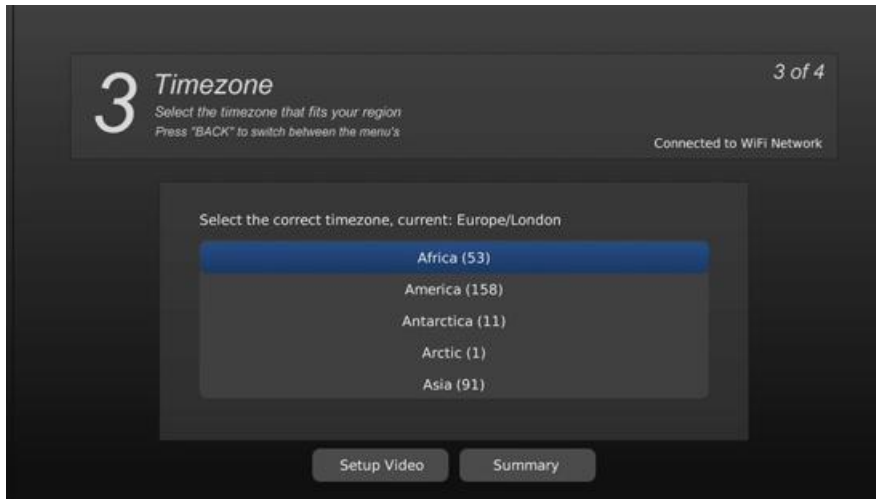

Step 7) Select your **region/time** zone.

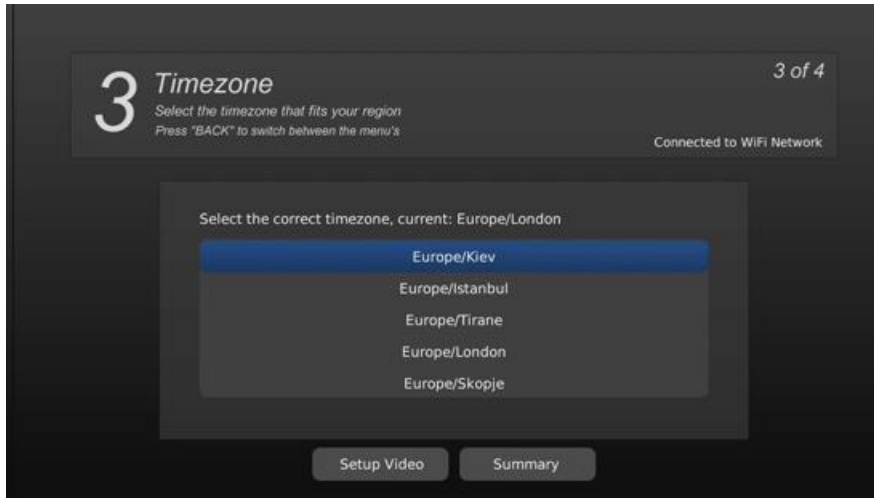

Step 8) Select **city**.

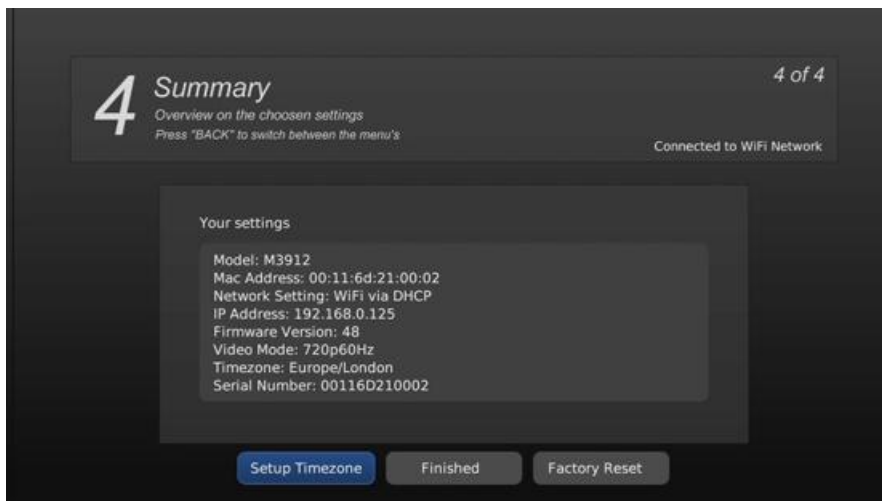

Step g) **Overview** of your selections.



Step 10) Your set-top box is now **connecting** to Internet.

5. TROUBLESHOOTING

Before calling your service provider, review this troubleshooting guide. This information is to help you quickly solve a problem. If your problem still exists, contact your service provider.

Problem	Possible Solution
The ZAAPTV GREEK set-top box will not power on	<p>The ZAAPTV GREEK set-top box may have received a software update and may not power on while the new software is being installed. Try again in a few minutes.</p> <ul style="list-style-type: none">● Verify that the AC power cord of the external power supply is connected to the ZAAPTV GREEK set-top box and an AC outlet. Unplug the ZAAPTV GREEK set-top box from the AC outlet, plug it back in.● If the ZAAPTV GREEK set-top box is connected to a switched outlet on another unit, verify that that unit is powered on. Unplug the power cord from the ZAAPTV GREEK set-top box AC outlet, plug it back it in. It is recommended to use an unswitched outlet, if possible.

<p>The remote control does not work</p>	<p>Verify that there are batteries in the remote control, and that they've been inserted with the correct polarities. Verify that there are no obstructions between the remote control and the ZAAPTV GREEK set-top box. Also check to see if there's any plastic cover on the front panel of ZAAPTV GREEK. If so, please remove it as it might affect the remote control reception. Aim the remote control directly at the ZAAPTV GREEK set-top box front panel, not the TV or VCR. The angle between the remote control and the ZAAPTV GREEK set-top box may be too large. Stand in front of the ZAAPTV GREEK set-top box and not too far to either side.</p> <ul style="list-style-type: none"> ● Press and release operation keys one at a time, firmly and deliberately. ● Check the batteries in the remote control. Install new batteries if needed.
<p>There is no audio when viewing channels</p>	<p>Verify that the mute button on the ZAAPTV GREEK set-top box or the remote control has not been pressed. Press mute on the remote control to restore sound.</p> <ul style="list-style-type: none"> ● If the ZAAPTV GREEK set-top box audio output is connected to the TV, verify that the mute button on the TV has not been pressed. ● If the ZAAPTV GREEK set-top box audio output is connected to a home theater receiver, verify that the receiver is set to the appropriate input source and the mute button on the receiver has not been pressed. ● Verify that you have the correct cables for the audio connections. ● Verify that the audio cables are firmly connected between the ZAAPTV GREEK set-top box and the audio play back device (TV, receiver, etc.).

No part of this document may be reproduced or transmitted in any form or by any means, electronic or mechanical, for any purpose, without the express written permission of Cloud Antenne Services Sarl. Under the law, reproducing includes translating into another language or format.